



GEARBOX FAULT DIAGNOSIS USING ADAPTIVE WAVELET FILTER

J. LIN AND M. J. ZUO

*Department of Mechanical Engineering, University of Alberta, Edmonton, AB, Canada T6G 2G8
E-mail: ming.zuo@ualberta.ca*

(Received 17 December 2001, accepted after revisions 21 June 2002)

Vibration signals from a gearbox are usually noisy. As a result, it is difficult to find early symptoms of a potential failure in a gearbox. Wavelet transform is a powerful tool to disclose transient information in signals. An adaptive wavelet filter based on Morlet wavelet is introduced in this paper. The parameters in the Morlet wavelet function are optimised based on the kurtosis maximisation principle. The wavelet used is adaptive because the parameters are not fixed. The adaptive wavelet filter is found to be very effective in detection of symptoms from vibration signals of a gearbox with early fatigue tooth crack. Two types of discrete wavelet transform (DWT), the decimated with DB4 wavelet and the undecimated with harmonic wavelet, are also used to analyse the same signals for comparison. No periodic impulses appear on any scale in either DWT decomposition.

© 2003 Elsevier Science Ltd. All rights reserved.

1. INTRODUCTION

Gearboxes are widely used in industrial applications. An unexpected failure of the gearbox may cause significant economic losses. It is, therefore, very important to find early fault symptoms from gearboxes. Tooth breakage is the most serious failure for a gearbox. Early detection of cracks in gears is essential for prevention of sudden tooth breakage. Usually, vibration signals are acquired from accelerometers mounted on the outer surface of a bearing case. The signals include vibrations from the meshing gears, shafts, bearings, and other parts. Thus, the signals are always complex and it is difficult to diagnose a gearbox from such vibration signals.

Misalignment of the shafts can be detected using sidebands [1]. Sidebands can be easily detected in the frequency domain since they are composed of only a few single-frequency components. As for crack recognition, the key is to find periodic impulses in signals [1]. Impulses are short in time duration and usually hidden in noises unless the crack is very big. Phase demodulation based on synchronous time average has been considered to be the most effective technique for crack detection in a gear [2]. Synchronous time average is an effective way to remove noises from periodic signals. Because the signal of interest is periodic and noises are random, the noises will tend to zero when the number of periods tends to infinity. However, the synchronous time-average technique needs a reference signal to ensure synchronisation and thus, a proximity probe should be used to obtain an accurate reference signal. Since it is often impossible to obtain such reference signals in practical applications, new techniques are needed to analyse signals for crack detection in gearboxes.

Wavelet analysis has been successfully used in non-stationary vibration signal processing and fault diagnosis [2–6]. Wavelet analysis is capable of providing both time-

domain information and frequency-domain information simultaneously. Similar to a wavelet function, the transient feature components of vibration signals have local energy distributions in both the time domain and the frequency domain. Wavelet functions can be used for detection of transient feature components because they have similar time–frequency structures. Since different types of wavelets have different time–frequency structures, we should use the wavelet whose time–frequency structure matches that of the transient component the best in order to detect the transient component effectively. Discrete wavelet transform (DWT) uses dyadic discretisation. The structures of both the decimated DWT and the undecimated DWT are too rigid for them to provide a good match to the structure of the transient component. During the last few years, continuous wavelet transform (CWT) has been used for gearbox diagnosis [2, 5]. However, the method used in [2] still requires a reference signal and the one mentioned in [5] has to select the threshold manually based on experience. An adaptive method should be set up to overcome those deficiencies.

In this paper, an adaptive wavelet filter based on Morlet wavelet is proposed. The shape of the wavelet filter (time–frequency resolution) is automatically adjusted based on the kurtosis maximisation rule. This filter is used to extract periodic impulses immersed in noisy signals for gear crack recognition. When the time series of the wavelet are convoluted with the signal, the filtered result is obtained. Because Morlet wavelet is a cosine function with exponential decay on both sides and is very much like an impulse, it is suitable for impulse detection. To get good performance of the filtering result, the scale and the time–frequency balance parameter for Morlet wavelet must be selected carefully. An adaptive method based on kurtosis maximisation is proposed for this task. We find that it is very effective for detecting periodic impulses hidden in noises.

This paper is organised as follows. The background introduction is given in Section 1. In Section 2, the adaptive Morlet wavelet filter is set up. Kurtosis maximisation is used for selection of the wavelet filter parameters. In Section 3, two types of DWT, the decimated one and the undecimated one, are used to detect fault symptoms for vibration signals from a gearbox with fatigue cracks on a gear. No abnormal features are found by either method. In Section 4, the adaptive wavelet filter is used for gear crack recognition. The periodic impulses are detected successfully by using this method. Conclusions are given in Section 5.

2. ADAPTIVE MORLET WAVELET FILTER

2.1. WAVELET TRANSFORM

Wavelet transforms are inner products between signals and the wavelet family, which are derived from the mother wavelet by dilation and translation. Let $\psi(t)$ be the mother wavelet, the daughter wavelet will be $\psi_{a,b}(t) = \psi((t - b)/a)$, where a is the scale parameter and b is the time translation. By varying the parameters a and b , we can obtain different daughter wavelets that constitute a wavelet family. Wavelet transform is to perform the following operation:

$$W(a, b) = \frac{1}{\sqrt{a}} \int x(t) \psi_{a,b}^*(t) dt \quad (1)$$

where ‘*’ stands for complex conjugation.

Many research results have been published on wavelet reconstruction. Early research focused on orthogonal wavelet reconstruction. It is rather easy to perform inverse wavelet transform for orthogonal wavelet. The latest research focuses more on non-orthogonal

wavelet reconstruction [7]. According to the original definition of wavelet transform, there is a universal reconstruction equation for any type of wavelet:

$$x(t) = C_{\psi}^{-1} \iint W(a, b) \psi_{a,b}(t) \frac{da}{a^2} db \quad (2)$$

where

$$C_{\psi} = \int_{-\infty}^{\infty} |\hat{\psi}(\omega)|^2 / |\omega| d\omega < \infty \quad (3)$$

$$\hat{\psi}(\omega) = \int \psi(t) \exp(-j\omega t) dt. \quad (4)$$

If a daughter wavelet is viewed as a filter, wavelet transform is simply a filtering operation. Usually, we attempt to discover feature signals by reconstructing the wavelet coefficients at selected scales or the wavelet coefficients shrunk through certain methods. To do this, we have to have prior information on the signal to be identified.

2.2. ADAPTIVE MORLET WAVELET FILTER

Morlet wavelet is one of the most popular non-orthogonal wavelets. The definition of Morlet is

$$\psi(t) = \exp(-\beta^2 t^2 / 2) \cos(\pi t). \quad (5)$$

It is a cosine signal that decays exponentially on both the left and the right sides. This feature makes it very similar to an impulse. It has been used for impulse isolation and mechanical fault diagnosis through the performance of a wavelet de-noising procedure [5]. However, in practice, it is not easy to provide a proper threshold for wavelet de-noising. We can avoid this by using an adaptive wavelet filter instead of wavelet de-noising.

The impulses that exist in vibration signals are usually different from theoretical impulses. Theoretical impulses have even energy distribution in the frequency domain. A simulated impulse that often exists in vibration signals is shown in Fig. 1(a). The corresponding frequency spectrum is shown in Fig. 1(b). Of course, such impulses are usually immersed in noisy signals. It can be easily seen from Fig. 1 that the frequency spectrum of the impulse does not have an even distribution. The main energy focuses on a specific frequency band and decays quickly with the increase and the decrease of the frequency, which is unlike that of a theoretical impulse. In addition, the decaying rates are different for the left and the right sides.

A daughter Morlet wavelet is obtained by time translation and scale dilation from the mother wavelet, as shown in the following formula [7]:

$$\psi_{a,b}(t) = \psi\left(\frac{t-b}{a}\right) = \exp\left[-\frac{\beta^2(t-b)^2}{2a^2}\right] \cos\left[\frac{\pi(t-b)}{a}\right] \quad (7)$$

where a is the scale parameter for dilation and b is the time translation. It can also be looked at as a filter.

To identify the immersed impulses by filtering, the location and the shape of the frequency band corresponding to the impulses must be determined first. Scale a and parameter β control the location and the shape of the daughter Morlet wavelet, respectively. As a result, an adaptive wavelet filter could be built by optimising the two parameters for a daughter wavelet.

Several researchers have reported on how to select the mother wavelet that adapts the best to the signal to be isolated [2, 7–11]. Details on how to select β in Morlet wavelet to make the mother wavelet match the signal to be isolated are provided in [5]. In this paper,

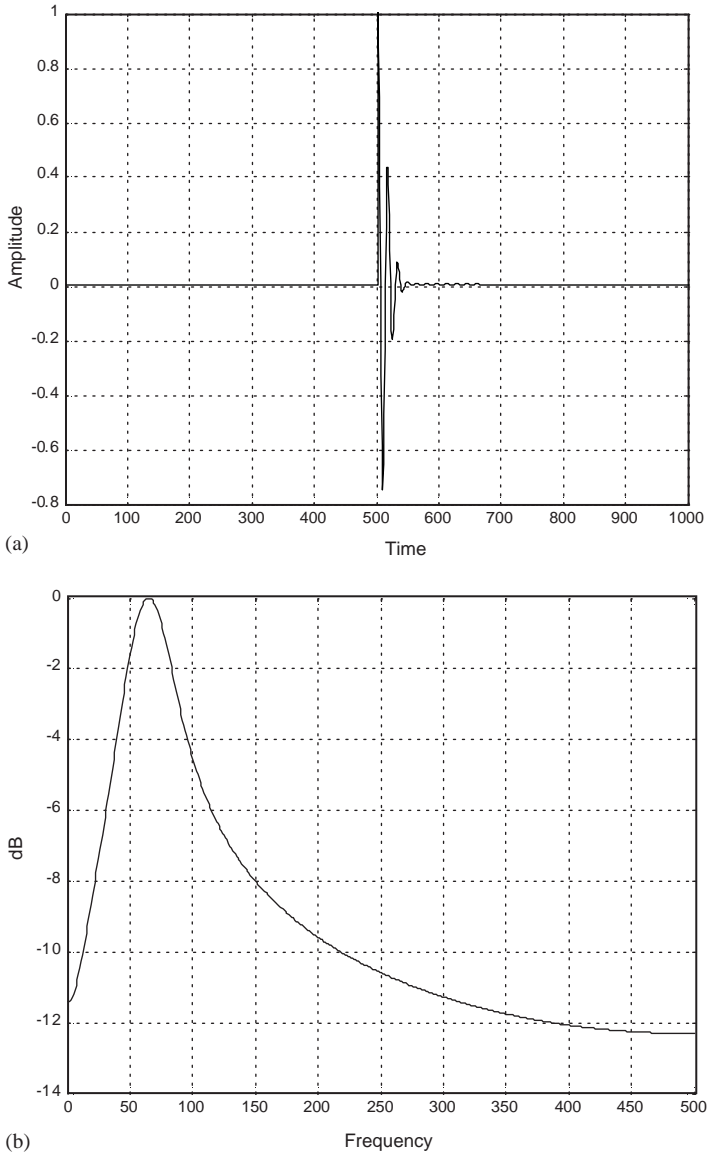

Figure 1. A simulated impulse. (a) The waveform of a simulated impulse. (b) The frequency spectrum of the simulated impulse.

we focus on finding the best wavelet filter (the daughter wavelet of a Morlet wavelet) instead of optimal wavelet reconstruction.

Wang has studied the differences between single- and double-sided Morlet wavelets [6]. Their frequency spectra are quite different. Since a real impulse is usually non-symmetric, we choose to use the right-hand side of Morlet wavelet as the basis. Such wavelets should match the behaviours of hidden impulses the best.

Kurtosis is used in engineering for detection of fault symptoms because it is sensitive to sharp variant structures, such as impulses [12]. The bigger the impulse in signals, the larger the kurtosis. As a result, kurtosis can be used as the performance measure of a Morlet

wavelet filter. The definition of kurtosis is

$$kurt(y) = E(y^4) - 3[E(y^2)]^2 \tag{6}$$

where y is the sampled time series and E represents the mathematical expectation of the series.

The procedure to perform the adaptive wavelet filtering is as follows:

- (1) Vary the parameters a and β within preselected intervals to produce different daughter wavelets.
- (2) Perform wavelet filtering using each daughter wavelet and calculate the kurtosis of each outcome.
- (3) Compare the kurtosis value. The parameters a and β that correspond to the largest kurtosis are the best parameters to use to reveal the hidden impulses.

3. GEARBOX VIBRATION SIGNAL PROCESSING USING DWT

Gearbox diagnosis is challenging in engineering because the vibration signals from a gearbox are complex. They usually represent vibrations from many different sources. Feature components are hidden among many irrelevant components. To diagnose the gearbox faults effectively, the most important thing is to isolate the feature components from original complex signals.

Two types of feature components are often encountered when faults occur. The first one is sideband, which usually indicates the faults relevant to misalignment. The second one is periodic impulse, which usually indicates tooth crack or even tooth breakage. Tooth crack must be detected early to prevent tooth breakage.

The gearbox in our experiment is illustrated in Fig. 2. Its transmission path is as follows.

$$input \rightarrow \left(\frac{Z28}{Z48}\right) \rightarrow \left(\frac{Z20}{Z44}\right) \rightarrow \left(\frac{Z30}{Z36}\right) \rightarrow \left(\frac{Z15}{Z42}\right) \rightarrow output.$$

To obtain the whole course from the appearance of tooth crack to tooth breakage, signals were sampled constantly. An accelerometer mounted on the outer surface of the output shaft bearing housing was used to acquire the vibration signals. The reason for selecting

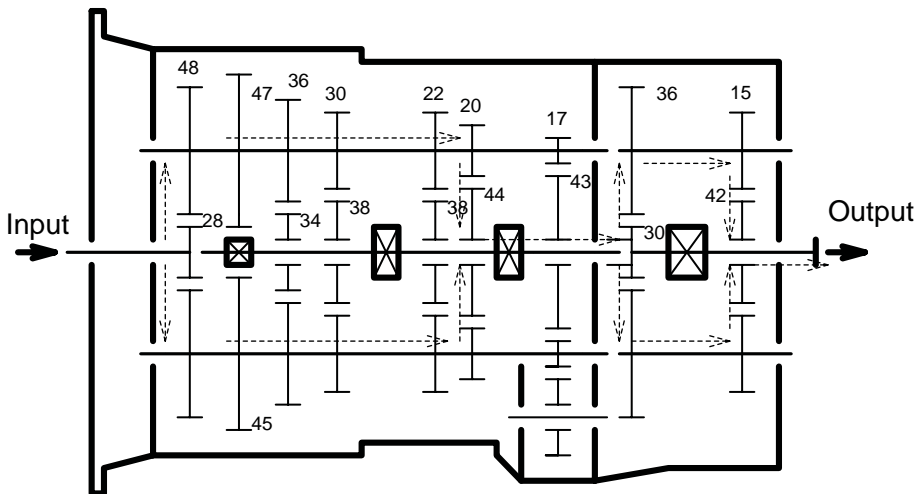

Figure 2. The transmission diagram of an automobile transmission box.

this spot to collect vibration signals is that the gear pair Z15/42 is the slowest and thus, endures the largest torque. Fatigue crack on gear tooth would appear first on this pair.

The rotating speed of the input shaft was 1600 r/min, i.e. 26.67 Hz. The rotating frequency of the output shaft was 2.1 Hz. The faulty gear was discovered to be the 42-tooth gear on the output shaft. Cracks appeared in two symmetrical teeth. The signals in this case should include the impulse components whose period equals 0.24 s. The signals were sampled at 5 KHz with a 2 KHz low-pass filter in advance. A few minutes before the tooth breakage, fatigue cracks were discovered. The collected signals should include periodic impulses due to crack.

Figure 3 shows the waveform with broken teeth. The waveform has clear impulses. Engineers usually try to detect cracks to prevent gear tooth breakage. There is no much use to analyse signals with broken teeth. On the other hand, Fig. 4 shows the signals collected before any tooth was broken. No periodic impulses appear on the waveform in Fig. 4 even though cracks may have appeared in the gear already. The periodic impulses of the cracks were hidden in the signals. Two different types of orthogonal wavelets were used to perform DWT for the signals shown in Fig. 4. Figure 5 shows the decimated wavelet transform result using DB4 wavelet. Figure 6 shows the undecimated wavelet transform result using harmonic wavelet proposed by Newland [13]. No obvious periodic impulses appear in Fig. 6. In Fig. 5, two sharp impulses appear in the subplot of scale 2^4 and in the subplot of scale 2^2 , while no impulses exist in other subplots. As a result, it is difficult to draw any conclusive result from either Fig. 5 or Fig. 6. As will be revealed later with the proposed adaptive wavelet filter, there are altogether three impulses in the signal.

4. GEAR TOOTH CRACK RECOGNITION USING ADAPTIVE WAVELET FILTER

As introduced in Section 2, Morlet wavelet is used to obtain the adaptive wavelet filter. Let parameter β vary from 0.1 to 4 with a step size of 0.1, the scale vary from 1 to 30 with a

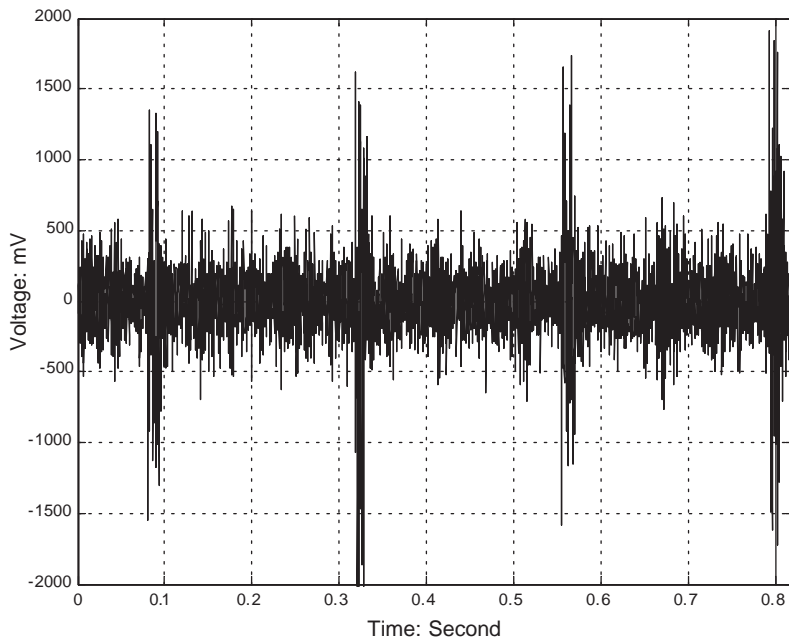

Figure 3. The waveform of the gearbox with a broken tooth.

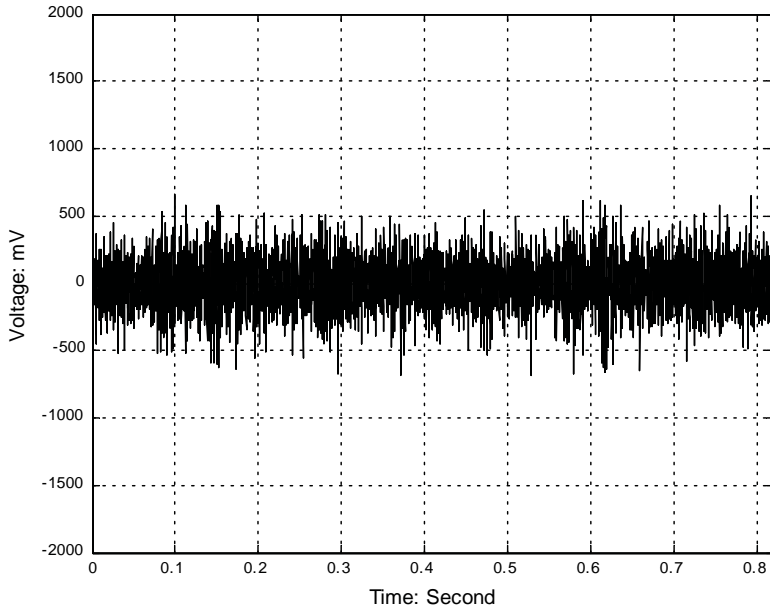

Figure 4. The waveform of the gearbox with tooth crack.

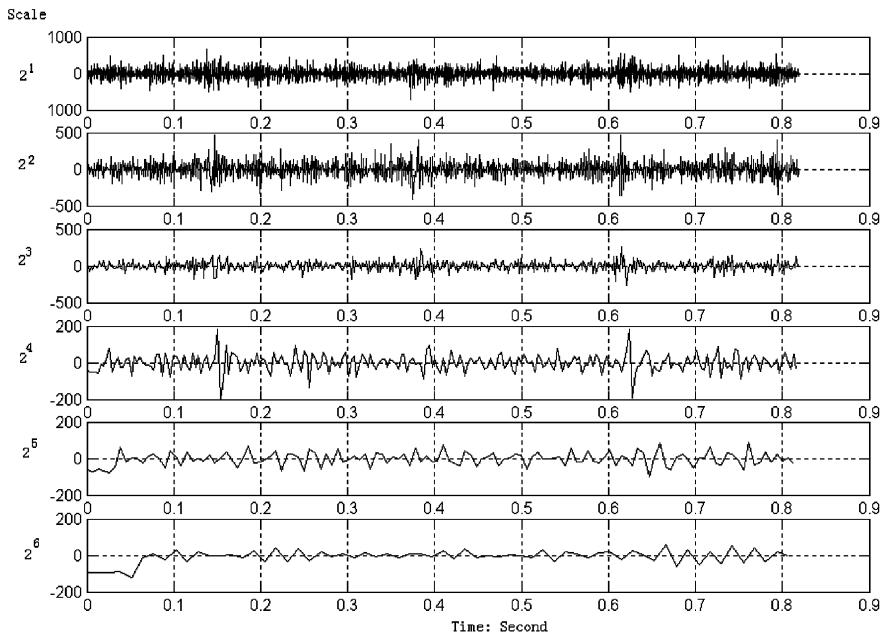

Figure 5. The DWT of the signals in Fig. 4 with the DB4 wavelet.

step size of 1. The largest kurtosis value of 8.8 is obtained when $\beta = 0.3$ and the scale equals to 19, as shown in Fig. 7. To illustrate the sensitivity of the kurtosis as a function of β , we fix the value of the scale to be 19 and plot the kurtosis– β relationship in Fig. 8, which shows that the kurtosis is very sensitive to the value of β . The filtering result with the

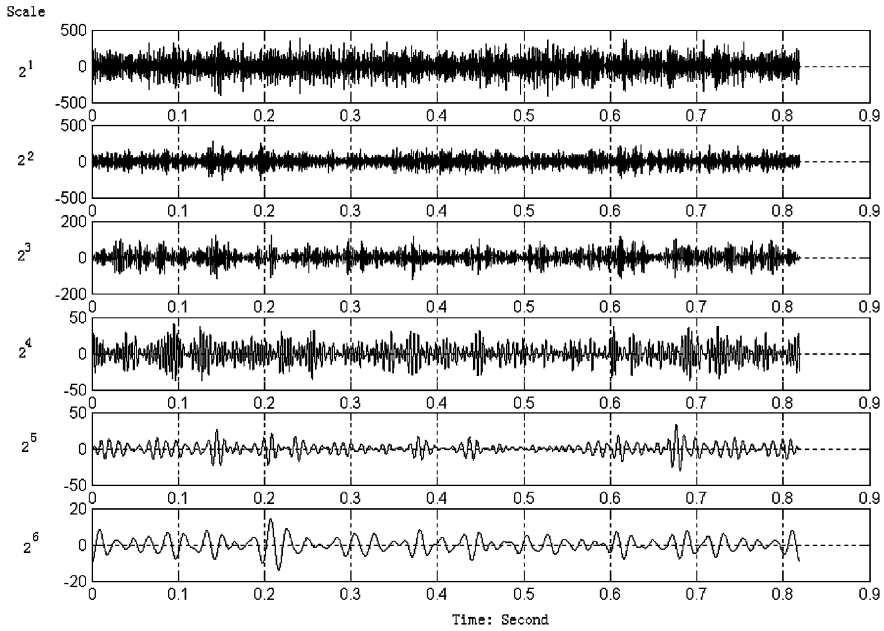

Figure 6. The DWT of the signals in Fig. 4 with the harmonic wavelet.

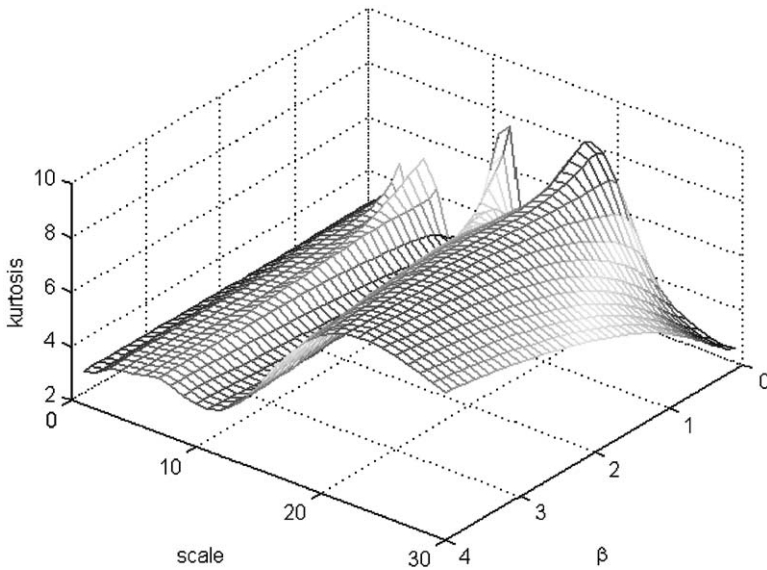

Figure 7. The kurtosis dstribution for different values of β and the scale.

optimised wavelet filter ($\beta = 0.3$ and $a = 19$) is shown in Fig. 9. Periodic impulses are obvious in Fig. 9. The period is just about 0.24 s.

To demonstrate the efficiency of the proposed adaptive wavelet filter, two other values of parameters a and β corresponding to relative large kurtosis are selected to produce two different wavelet filters. One set of parameter values is $a = 12$ and $\beta = 0.1$ and the corresponding kurtosis value is equal to 7.9. The results with this wavelet filter are shown

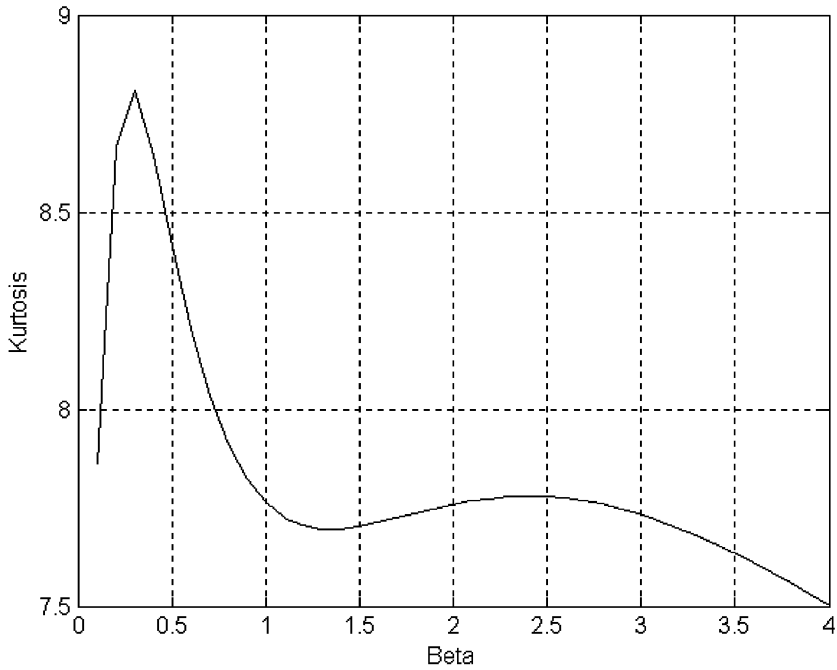

Figure 8. The kurtosis as a function of β when the scale $a = 19$.

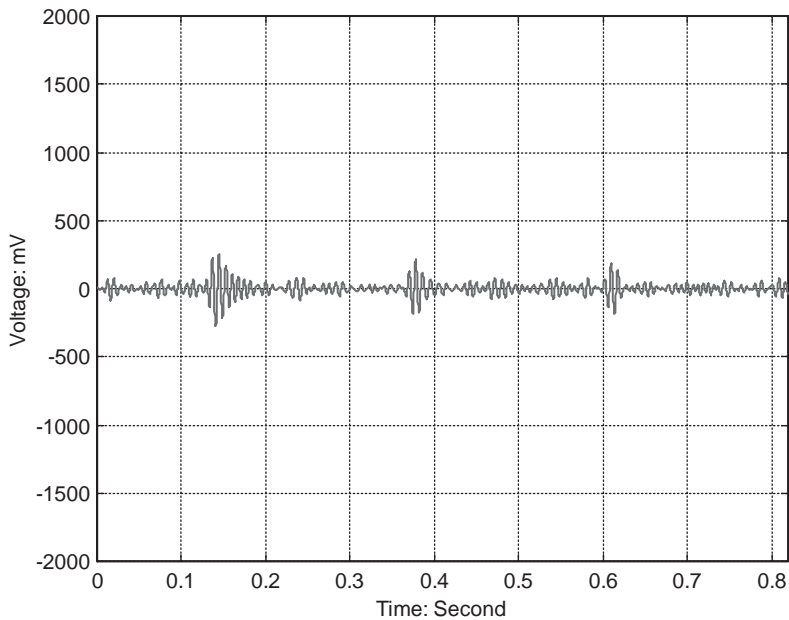

Figure 9. The adaptive filtering result for the vibration signals of the gearbox with tooth crack.

in Fig. 10. There is still heavy noise in the waveform shown in Fig. 10. Only two impulses appear in Fig. 10 and the impulses look obscure. Another set of parameter values is $a = 27$ and $\beta = 4$ and the corresponding kurtosis value is equal to 8.0. The results with this wavelet filter are shown in Fig. 11. In Fig. 11, the three impulses are clearer because the

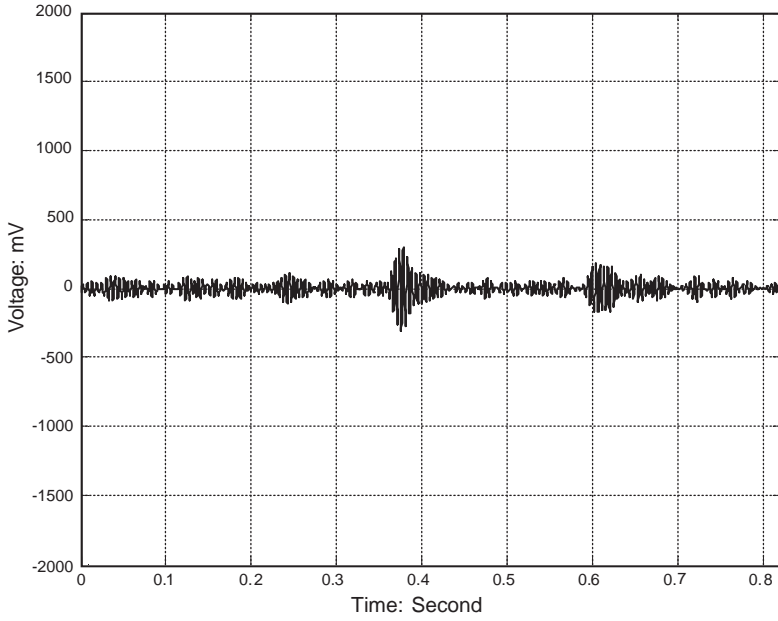

Figure 10. The filter result when $\beta = 0.1$ and the scale $a = 12$ for the wavelet filter.

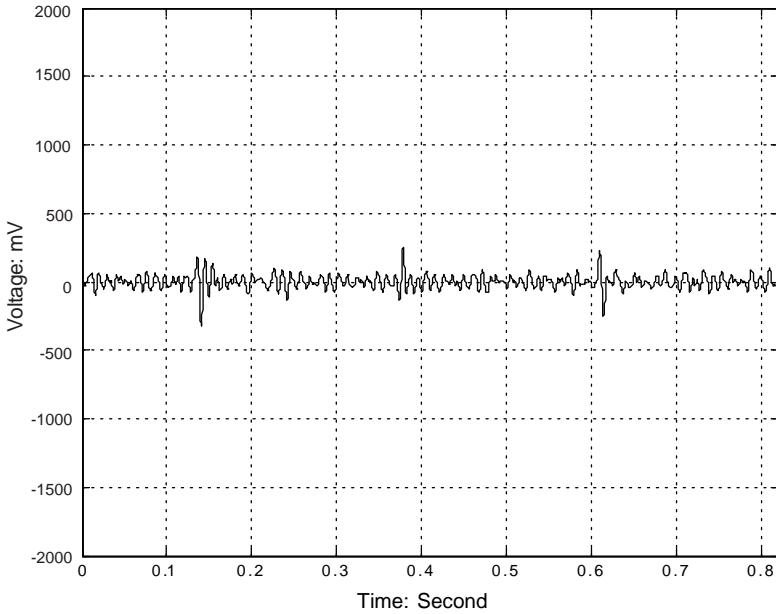

Figure 11. The filter result when $\beta = 4$ and the scale $a = 27$ for the wavelet filter.

kurtosis value is larger than the last one. Compared with the waveform shown in Fig. 9, the impulses in Fig. 11 have smaller time duration. This shows that the wavelet filter obtained with the largest kurtosis value provides the best filtering results.

5. CONCLUSIONS

Wavelets are essentially octave filters. Wavelet decompositions amount to performing filtering for signals. Researchers and engineers are used to performing this operation using Mallat or a trous algorithm while seldom conducting optimisation on the filter. The adaptive wavelet filter proposed in this paper represents an attempt in the direction of optimising the filter.

Morlet wavelet can be used for impulse detection due to its similarity to an impulse. Any daughter wavelet can be viewed as a filter. To identify impulses hidden in noisy signals by filtering, the daughter wavelet should match the time–frequency structure of the impulse well. An adaptive Morlet wavelet filter based on kurtosis maximisation is proposed to detect periodic impulses automatically for recognition of gear tooth fatigue crack. Compared with other orthogonal wavelet decompositions, the result obtained by this method is more effective for capturing impulses.

ACKNOWLEDGEMENTS

The vibration data used in this study were provided by the Research Institute of Diagnostics & Cybernetics, Xi'an Jiaotong University, P.R. China. Support from Natural Sciences and Engineering Research Council of Canada is acknowledged.

REFERENCES

1. R. L. ESHLEMAN 1999 *Basic Machinery Vibrations*. Clarendon Hills, IL: VIPress, Incorporated.
2. D. BOULAHBAL, M. F. GOLNARAGHI and F. ISMAIL 1999 *Mechanical Systems and Signal Processing* **13**, 423–436. Amplitude and phase wavelet maps for the detection of cracks in geared systems.
3. Z. GENG and L. QU 1994 *Insight* **36**, 11–15. Vibrational diagnosis of machine parts using the wavelet packet technique.
4. W. J. WANG and P. D. MCFADDEN 1996 *Journal of Sound and Vibration* **192**, 927–939.
5. J. LIN and L. QU 2000 Feature extraction based on Morlet wavelet, its application for mechanical fault diagnosis. *Journal of Sound, Vibration* **234**, 135–148. Application of wavelets to gearbox vibration signals for fault detection.
6. W. J. WANG 2001 *Mechanical Systems and Signal Processing* **15**, 685–696. Wavelets for detecting mechanical faults with high sensitivity.
7. M. J. SHENSA 1996 *IEEE Transactions on Signal Processing* **40**, 2464–2482. The discrete wavelet transform: wedding the a trous and Mallat algorithms.
8. R. R. COIFMAN and M. V. WICKERHAUSER 1994 *Optical Engineering* **33**, 2170–2174. Adapted waveform analysis as a tool for modeling, feature extraction, and denoising.
9. P. AUSCHER, G. WEISS and M. V. WICKERHAUSER 1992 In: *Wavelets—A Tutorial in Theory and Applications*, pp. 237–256. Boston: Academic Press. Local sine and cosine bases of Coifman and Meyer and the construction of smooth wavelets.
10. S. S. CHEN 1995 Ph.D. dissertation, Department of Statistics, Stanford University. Basis Pursuit.
11. M. R. McCLURE and L. CARIN 1997 *IEEE Transactions on Signal Processing* **45**, 2912–2927. Matching pursuits with a wave-based dictionary.
12. L. QU and Z. HE 1986 *Mechanical Diagnostics*. P. R. China: Shanghai Science and Technology Press.
13. D. E. NEWLAND 1994 *ASME Transactions, Journal of Vibration and Acoustics* **116**, 409–425. Wavelet analysis of vibration, Part 1: theory, Part 2: wavelet maps.